

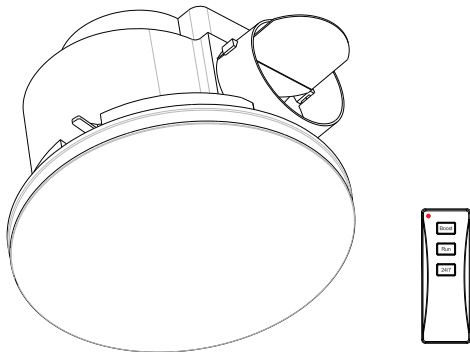

THE AIR MOVEMENT SPECIALISTS

INSTRUCTION MANUAL

AIRBUS EC
24/7 HEALTHY VENTILATION



(This photo is for reference only; it does not mean you are purchasing an identical product. Fan picture is for illustration purposes only. Styles may vary according to the model.)

Installation Manual, Rev 1.0

Models (Including all fascia options):

**PVPXEC200, PVPXEC200RD, PVPXEC200SQ,
PVPXEC200RD-LED, PVPXEC200SQ-LED
PVPXEC500, PVPXEC500RD, PVPXEC500SQ,
PVPXEC500RD-LED, PVPXEC500SQ-LED**

CAUTION

Read Instructions Carefully
For Safe Installation and
Fan Operation

CONTENTS

- TECHNICAL DATA
- DIMENSIONS
- INSTALLATION CAUTION
- INSTALLATION
- OPERATION
- MAINTENANCE
- STORAGE AND DISPOSAL

THANK YOU FOR PURCHASING

Thank you for purchasing this quality Exhaust fan. To ensure correct function and safety, please read all instructions before using the product and keep all instructions for future reference.

BEFORE INSTALLATION CAUTION



WARNING

When using electrical appliances, basic safety precautions should always be followed to reduce the risk of fire, electrical shock and personal injury.

TECHNICAL DATA

Model No:	PVPXEC200	PVPXEC500
Rated Voltage:	220-240V~,50Hz	220-240V~,50Hz
FAN Power Input:	24-3W	80-3W
Noise(dB):	37-28dB(A)	44-21dB(A)
Duct Size:	100mm Diameter	150mm Diameter
Air Delivery:	245-65m ³ /h	510-70m ³ /h

DIMENSIONS

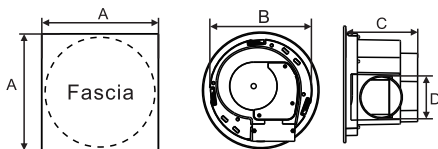

MODELS	A	B cut out \varnothing	C	D
PVPXEC200 models	272mm	\varnothing 240mm	170mm	\varnothing 95mm
PVPXEC500 models	326mm	\varnothing 300mm	197mm	\varnothing 143mm



IMPORTANT

FAN INSTALLATION AND ELECTRICAL CONNECTION MUST BE CARRIED OUT BY A LICENSED ELECTRICIAN.

IMPORTANT:

- 1.This appliance is not intended for use by persons (including children) with reduced physical, sensory or mental capabilities, or lack of experience and knowledge, unless they have been given supervision or instruction concerning use of the appliance by a person responsible for their safety.
- 2.Children should be supervised to ensure that they do not play with the appliance.
- 3.Never install the fan where it is extremely hot!
- 4.Ensure there is at least 5cm between the fan and the roof when installing.
- 5.Minimum installation height is 2.1 metres from the floor to the bottom of the exhaust fan.
- 6.If the room where the fan is to be installed already contains a stove, water heater or a gas fire, it is essential to ensure that the air supply to the room is enough for both the fan and the combustion appliance.
- 7.Please ensure the appliance has not been damaged before installing.
- 8.Check the electrical specifications label corresponds to your electrical supply
- 9.When using a double pole switch connection, the switch must be with a minimum 3mm separation on all poles.
- 10.When ducting the exhaust, ensure the duct is not bent into the following shapes. (See image below)
- 11.All wiring must be carried out by a licensed electrician.
- 12.If the supply cord is damaged, it must be replaced by the manufacturer, its service agents or similar qualified person in order to avoid a hazard.

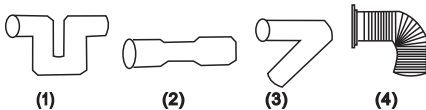

IMPORTANT CONSIDERATION BEFORE INSTALLING

- 1.Adhere to the latest national wiring rules AS/NZS3000, for wiring and when installing in bathrooms, nearby sinks and water taps.
- 2.For the exhaust fan to work efficiently, replacement air of volume equivalent to what is being extracted must be able to enter the room. In general, this air would be drawn under the door or through a slightly opened window. If the room is air tight, the fan will function poorly.
- 3.Before commencing any cutting, check the mounting location to ensure there is no obstruction such as ceiling frames, or joists. Check the electrical wiring can be routed from the wall switch to the mounting location.
- 4.This fan is not intended for mounting in outside windows or walls.

INSTALLATION



WARNING

BEFORE INSTALLING THE FAN, MAKE SURE YOU HAVE TURNED OFF THE MAIN ELECTRICITY SUPPLY.
DO NOT TURN IT BACK ON UNTIL THE FAN IS FULLY INSTALLED AND READY TO USE.

Note: A means for disconnection must be incorporated in the fixed wiring in accordance with the wiring rules.

1. Check the fan is free to rotate.
2. Cut the hole for the fan using the template provided, making sure the area behind the intended position is free from impediments.
3. Plug into a socket outlet and secure fan body using the three (or four) swing fixing arms. Use Philips head screw driving to firmly secure but do not over tighten.
4. Ducting can be attached to the air outlet prior to installing into position.

Note: A standard socket and electrical wiring to an ON/OFF wall switch must be pre-installed. Please arrange a Licensed Electrician to prepare the socket outlet and ON/OFF wall switch before carrying out the installation of this appliance.

5. Switch the fan ON and check for excessive vibration or noise.
6. If fan is running as desired, secure the fascia by squeezing the spring fasteners and insert into the slot in the fan body. Check that the fascia is secured firmly and closely to the fan body.

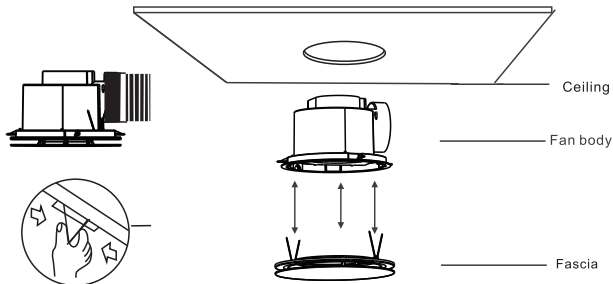

Note: When installing the fan in a bathroom, the duct should decline downwards about 10 degrees.

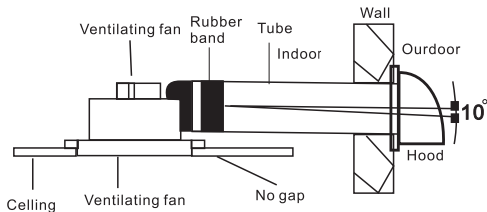

OPERATION

1. **Boost** Set the fan to run at maximum speed for 10 minutes, after which it will automatically switch to 24/7 mode (continuous run at low speed).
2. **Run** Set the fan to run at the normal speed for 20 minutes. after which it will automatically switch to 24/7 mode (continuous run at low speed).
3. **24/7** Set the fan to run continuously at low speed, and it will stop only when the wall (isolation) switch is switched to "OFF".

NOTE: The exhaust fan can be turned on/off by the wall (isolation) switch (not included). When the switch is turned on, the fan will operate at the Normal(RUN) speed for 20 minutes, after which it will automatically switch to 24/7 mode (continuous run at low speed)

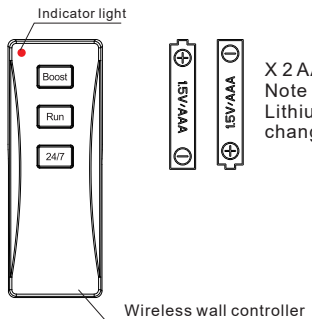

X 2 AAA batteries included.

Note : Use good quality Lithium batteries to extend time between Battery changes.

Indicator light will Flash Red when Battery charge falls below 20%.

INSTALLING FASCIA WITH LED

WHEN INSTALLING WITH AN LED FASCIA

1. Remove the double-sided tape and attach the LED driver to the fan body. (See diag. 1)
2. Plug the Fan and LED driver into a socket outlet. Knock out the stamped tab in the motor body and feed the LED output connector through. (See diag. 2)
3. Secure fan body to the ceiling using the 3 (or 4) clips and screw to tighten.
4. Connect the LED connector to the LED driver securely. (See diag. 3)
5. Push the LED cable connector back through the hole so the connectors are hidden in the ceiling cavity. (See diag. 4)

Diagram 1
Attach the LED driver to the fan body as shown.

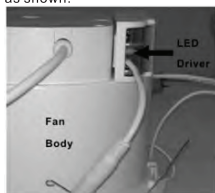

Diagram 2
Pull through connector



Diagram 3
Connect connector to the LED driver

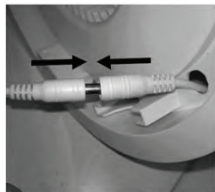
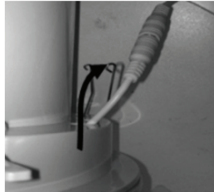

Diagram 4
Push LED connectors into ceiling



Note: LED lamp and LED driver are replaceable. To replace – disconnect female and male connectors and replace new LED lamp or LED driver.

Note: To avoid overheating DO NOT cover the LED driver with roof insulation.

Note: For Fascias with tri colour LED, set the switch on driver to desired Colour temperature prior to installation.

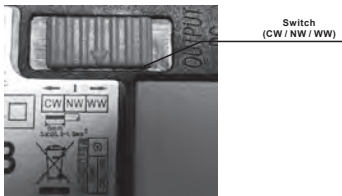
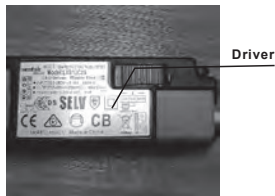

6. Secure the fascia by squeezing the fastening springs and insert into the slots in the fan body. Check that the fascia is secured firmly and is sitting closely to fan body.

Note: Switch the fan on and check for excessive vibration or abnormal noise before installing the fascia.

MAINTENANCE CAUTIONS



WARNING

BEFORE REPAIRING THE FAN, MAKE SURE YOU HAVE TURNED OFF THE MAIN ELECTRICITY.

1. Make sure the fan is always switched off before cleaning.
2. Make sure to use the fan with the specified voltage as stated on the rating sticker.
3. Never immerse any part of the fan in water or other liquids.
4. Never use petrol benzene or any other such chemicals for cleaning the fan.
5. Never allow water to contact the electrical parts such as switch and motor.
6. Never immerse blades or other resin parts in hot water over 60°C.
7. Never install the fan under extreme hot environments.

CLEANING, STORAGE AND DISPOSAL

Before cleaning, turn the unit off, cut off the power supply from electrical outlet and wait for the unit to cool down.

- To clean the unit, use a soft cloth to wipe off any dust.
- Do not try to open the unit without a licensed electrician. Improperly installed units can be dangerous.
- Have your product repaired by a licensed electrician.
- This product is in accordance with the relevant safety requirements. Repairs should only be carried out by licensed electricians using original spare parts, otherwise this may result in considerable danger to the user.
- For any aftersales requirements please refer to enclosed warranty card.

If you do not plan to use the fan for extended periods of time, it is recommended that it is cleaned and stored (preferably in its original packaging) in a cool, dry place.

Do not dispose of electrical products with household waste. Please check with your local council for advice on disposal or recycling. If electrical appliances are disposed of in landfills or dumps, hazardous substances can leak into the groundwater and get into the food chain, damaging your health and well-being.